

Downs Crane & Hoist Company

96 Series Spreader Beam

ITEM #96-60-16

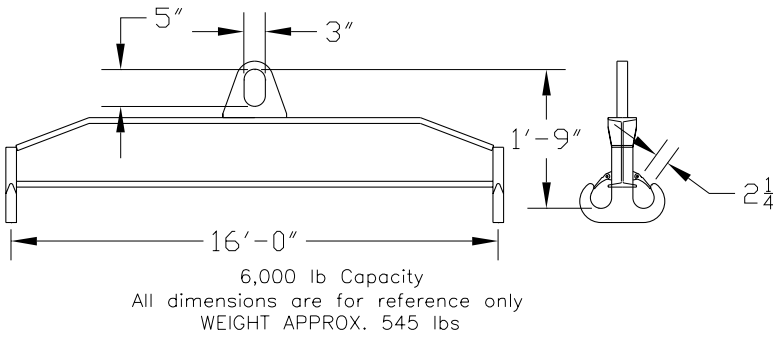

Key Features

- Lifting eye made of Mild Steel to protect Crane Hook
- Inner upper edges of lifting eye chamfered and ground to help protect crane hook
- Ends of Spreader Beam are beveled to reduce sharp edges to help protect operators and to reduce weight
- Oversized Twin Hooks are chamfered and ground for use with nylon slings
- Latches on hooks are included as standard equipment
- Designed to meet or exceed our interpretation of applicable OSHA and ANSI/ASME B30-20 Standards
- See Series 97 Sheets for alternate end fittings

Sample Spreaders

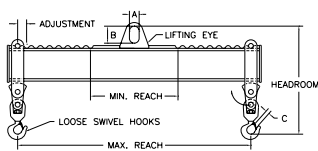

Series 100 Spreader Beam

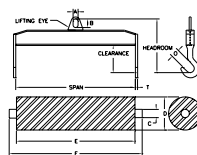

Series 101 Spreader Beam

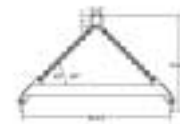

Series 102 Spreader Beam

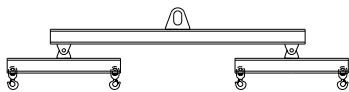

Series 103 Spreader Beam

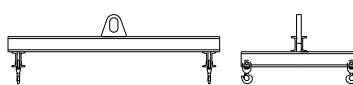

Series 104 Spreader Beam

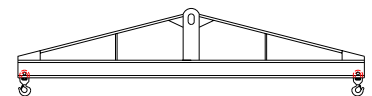

Series 105 Spreader Beam

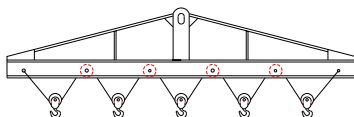

Series 106 Spreader Beam

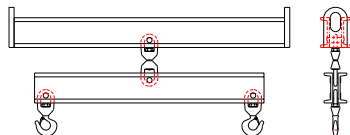

Series 109 Spreader Beam

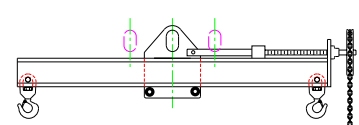

Series 110 Spreader Beam

Phone: (323)589-6061

Toll Free: (800)748-5994
www.downscrane.com

FAX: (323)589-6066