

Downs Crane & Hoist Company

Basic Spreader Beam Designs

ITEM #97-20-12

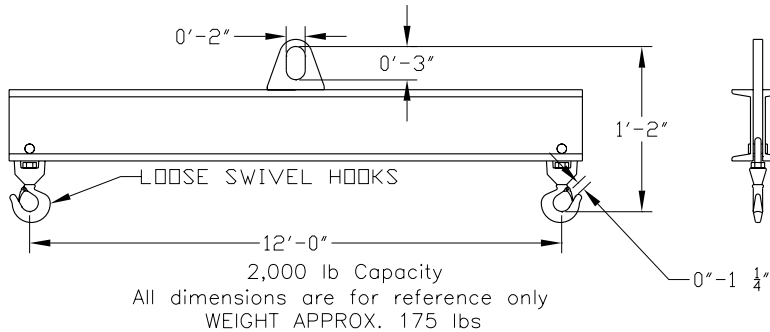

Key Features

- Lifting eye made of Mild Steel to protect Crane Hook
- Inner upper edges of lifting eye chamfered and ground to help protect crane hook
- Ends of Spreader Beam are beveled to reduce sharp edges to help protect operators
- Oversized Swivel Hooks are standard to allow easy attachment of loads
- Latches on hooks are included as standard equipment
- Designed to meet or exceed our interpretation of ASME B30-20 standard



Sample End Fittings

A	B	C	D	E	F	G	H
I	J	K	L	M	N	O	P
Q	R	S	T	U	V	W	X
Y	Z	AA	AB	AC	AD	AE	AF

Phone: (323)589-6061

Toll Free: (800)748-5994

FAX: (323)589-6066

www.downscrane.com