

# Downs Crane & Hoist Company

## Basic Spreader Beam Designs

ITEM #97-400-9

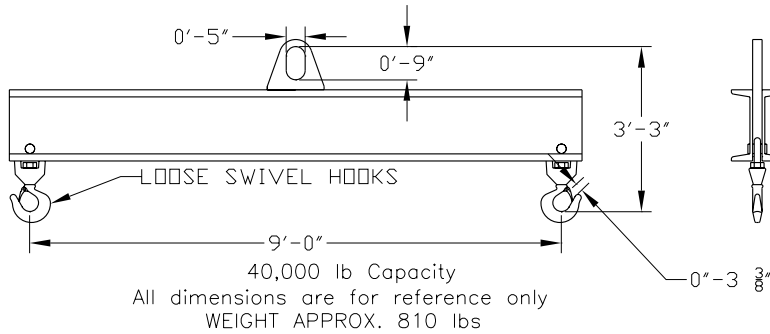

### Key Features

- Lifting eye made of Mild Steel to protect Crane Hook
- Inner upper edges of lifting eye chamfered and ground to help protect crane hook
- Ends of Spreader Beam are beveled to reduce sharp edges to help protect operators
- Oversized Swivel Hooks are standard to allow easy attachment of loads
- Latches on hooks are included as standard equipment
- Designed to meet or exceed our interpretation of ASME B30-20 standard



### Sample End Fittings

|   |   |    |    |    |    |    |    |
|---|---|----|----|----|----|----|----|
| A | B | C  | D  | E  | F  | G  | H  |
| I | J | K  | L  | M  | N  | O  | P  |
| Q | R | S  | T  | U  | V  | W  | X  |
| Y | Z | AA | AB | AC | AD | AE | AF |

Phone: (323)589-6061

Toll Free: (800)748-5994

FAX:(323)589-6066

www.downscrane.com